

University of Würzburg
Institute of Computer Science
Research Report Series

**On the Code and Soft Capacity of the
UMTS FDD Downlink and the Capacity
Increase by using a Secondary Scrambling
Code**

Dirk Staehle

Report No. 413

April 2007

University of Würzburg,
Institute of Computer Science
Department of Distributed Systems
Am Hubland, 97074 Würzburg
Germany
staehle@informatik.uni-wuerzburg.de

On the Code and Soft Capacity of the UMTS FDD Downlink and the Capacity Increase by using a Secondary Scrambling Code

Dirk Staehle

University of Würzburg,
Institute of Computer Science
Department of Distributed Systems
Am Hubland, 97074 Würzburg
Germany
staehle@informatik.uni-wuerzburg.de

The downlink capacity of a UMTS FDD network is limited by the number of available channelization codes (code capacity) and by the available NodeB transmit power (soft capacity). The channelization codes of one sector are taken from an OVSF tree such that the number of codes per spreading factor is equal to the spreading factor itself. In the case that the codes of the OVSF tree are already exploited and the required transmit power is still clearly below its maximum, it is possible to establish another OVSF tree by using a secondary scrambling code. In this paper we develop a Monte Carlo simulation model for comparing the code capacity with the soft capacity of a UMTS network with sectorization, soft and softer handover. Several factors of influence like the orthogonality factor, the user activity, or the codes and power that are reserved for the HSDPA are investigated. Additionally, the capacity increase by using a second OVSF tree with the secondary scrambling code is studied.

1 Introduction

The downlink capacity of a UMTS network is limited by both the number of available channelization codes and the multiple access interference. Most research regarding the downlink capacity, however, either investigates the soft (power limited) capacity [1, 2] and neglects the code capacity or is dedicated to efficient code management strategies [3, 4]. In textbooks on UMTS radio network planning, see e.g. [5], the ratio of code and soft capacity is discussed with rough approximations only. In [6], an admission control scheme is proposed that considers both code and power resources. The capacity increase by using a secondary scrambling code was almost completely ignored and to the best of our knowledge the first work on it, [7], has been recently published. The approximative downlink pole capacity formulas from [1] are extended to the secondary scrambling code and the capacity increase is studied depending on several parameters.

However, the approximative formulas allow only a first insight in the benefits of the secondary scrambling code and the impact of sectorization, soft, and softer handover have been neglected.

The objective of this paper is to find out in which cases the UMTS downlink capacity is code limited and in which cases the capacity is power limited. Therefore, the impact of the orthogonality factor, the size of the soft and softer handover areas, and in particular the activity of the users is studied. Additionally, we consider the case when the high speed downlink packet access (HSDPA) consumes a part of the available codes and power. A semi-analytic Monte Carlo simulation technique is utilized for evaluating the required codes and transmit powers in a scenario that considers sectorization, soft and softer handover, and the use of the secondary scrambling code. The rest of this paper is organized as follows: Section 2 describes how the spreading and scrambling operations work together on the UMTS downlink and Section 3 explains the code limitation when using a single OVSF tree. Section 4 presents a short analysis of code and soft (power) blocking probabilities that rely on the pole capacity formula developed in [1]. A Monte Carlo simulation model for computing the code and power requirements is given in Section 5. In Section 6 we investigated the impact of various factors on the balance of code and soft capacity. Finally, the paper is concluded in Section 7.

2 Spreading and scrambling in UMTS FDD

The UMTS uses a combination of channelization and scrambling codes for separating the users' signals on the downlink. Fig. 1 shows the modulation, spreading, and scrambling operation for a sector using a primary (P-Sc) and a secondary (S-Sc) scrambling code. The physical channels $PhysCH_{1,i}$ on the P-Sc are either common or dedicated channels, and the physical channels $PhysCH_{2,i}$ on the S-Sc are dedicated channels. The QPSK modulation divides the bit streams of the physical channels into the I-branch and the Q-branch. The I- and Q-branch are then spread to the chipping rate using the same channelization code and afterwards treated as a single complex valued sequence of chips. The chip sequences of the physical channels are then multiplied with either the complex-

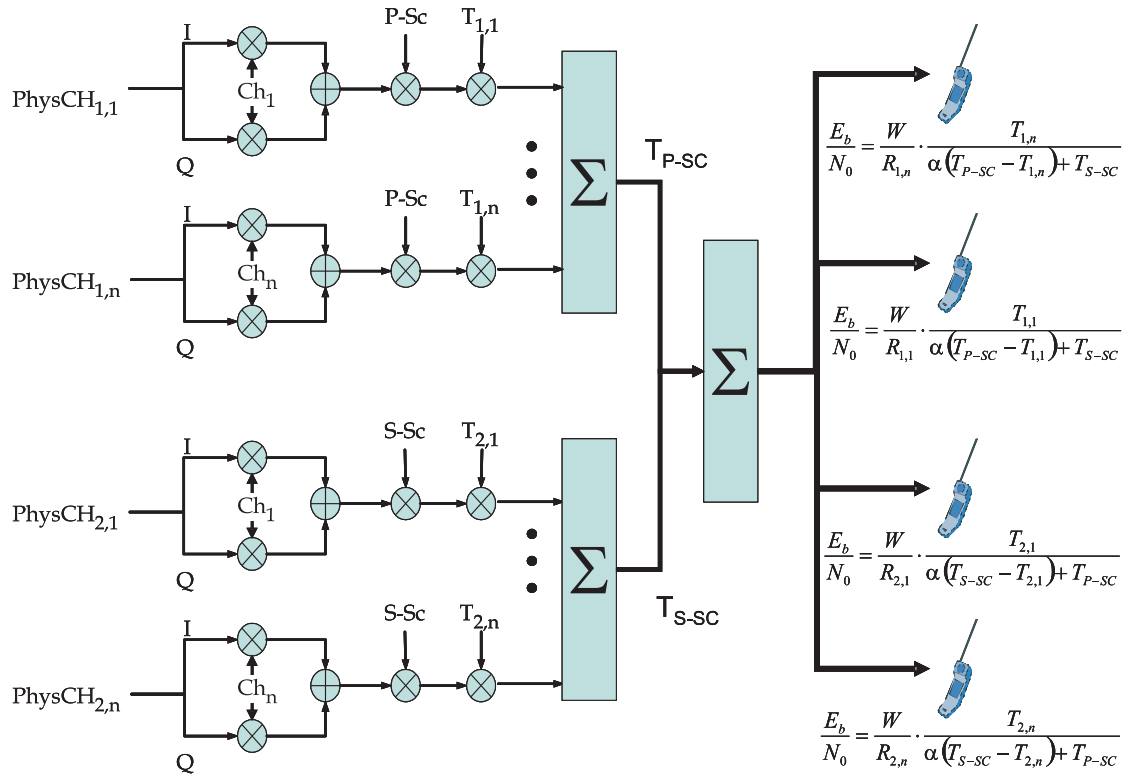

Figure 1: Spreading and scrambling operation with primary and secondary scrambling code

valued P-Sc or S-Sc. At the next step, the chip sequence is multiplied with a weight that effectively defines the transmit power $T_{c,i}$ for the physical channel $PhysCH_{c,i}$. The weighted chip streams are aggregated and we obtain the power T_{P-Sc} and T_{S-Sc} for the primary and secondary scrambling codes. The sum of the powers of both scrambling codes yields the total power S_z for a sector z . At the receiver, the signals are multiplied again with the respective scrambling code and afterwards de-spread with the mobile's channelization codes. Thus, the signal of a physical channel is orthogonal to all other signals of the same scrambling code and theoretically, the orthogonal signals cause no interference at all. Due to multipath propagation, however, the perfect orthogonality is lost and a part of the power is seen as interference. The orthogonality factor α defines the share of the power from the own scrambling code that contributes to the interference. The signals on the other scrambling code are not orthogonal and are consequently seen as interference. The resulting E_b/N_0 (bit-energy-to-noise-ratio) is the processing gain $W/R_{c,i}$ multiplied with the signal-to-interference-ratio. The formulae for the E_b/N_0 value in the figure consider the own cell interference only. Equations including the other sources of interference, i.e. the thermal noise spectral density and the other-cell/sector interference I_{other} are given in Section 5.

3 OVSF code tree

The channelization codes are taken from an OVSF tree (orthogonal variable spreading factor) as shown in Fig. 2. The OVSF tree has the property that once a code is used all its predecessors and successors in the tree are blocked. The codes in all subtrees that do not contain an occupied code and have no occupied predecessor, are still free. In the example in Fig. 2 the two black codes are occupied. They block the codes marked with the crosses while the other codes are still accessible. There is a series of research papers, e.g. [3, 4], that propose sophistic strategies for code allocation and re-allocation. In this paper we always assume a perfect arrangement of the codes in the code tree such that its capacity is fully utilized. The UMTS uses spreading factors between 4 and 512 on the downlink. The chip rate is 3.84Mcps such that e.g. a spreading factor of 16 corresponds

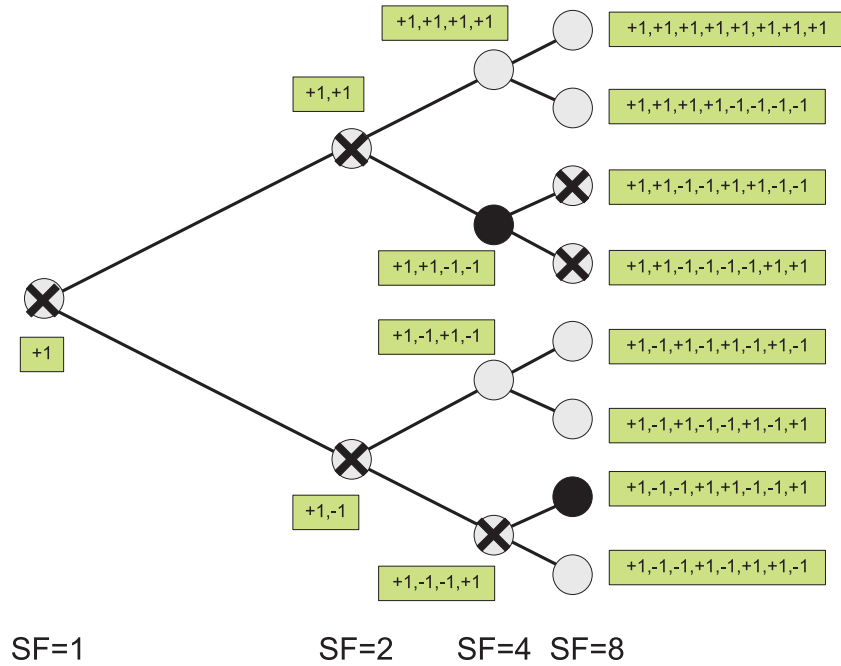

Figure 2: Beginning of the OVSF tree

to a symbol rate of 240ksps. With QPSK modulation this corresponds to a raw bit rate of 480kbps. However, this data rate can not be completely utilized due to headers and forward error correction. Finally, a radio access bearer (RAB) that provides a netto data rate of 144kbps requires a spreading factor of 16. A set of RABs [5] with netto bit rates and spreading factors is shown in Tab. 1. The last column of the table additionally gives the equivalent number of codes with the largest spreading factor 512.

4 Code blocking vs. soft blocking

If we use the SF512 codes as a basic unit the code blocking probability can be computed according to the Kaufman/Roberts-recursion [8, 9]. Let us assume that we have S different services and the users of each service class arrive according to an independent Poisson process and have a general holding time. This results in an offered load a_s of service s that requires c_s SF512 code equivalents. The users share C codes which are the total 512 codes of the OVSF tree minus the codes reserved for common and shared

netto bit rate	spreading factor	raw bit rate	equivalent number of SF512 codes
12.2kbps	128	60kbps	4
64kbps	32	240kbps	16
144kbps	16	480kbps	32
384kbps	8	960kbps	64

Table 1: Overview of (downlink) RABs in UMTS

service	R_s	c_s	ν_s	\tilde{r}_s	a_s
1	12.2kbps	4	1	0.01 - 0.018	12-24
2	144kbps	32	1	0.045 - 0.083	4-12

Table 2: Reference service mix

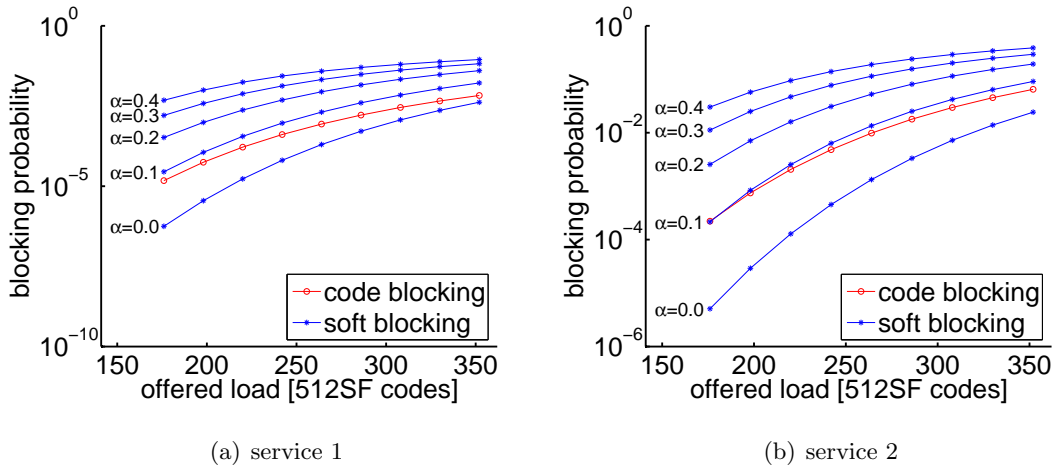

Figure 3: Impact of orthogonality factor on the relationship of code and soft blocking

channels. The probability $p(j)$ that j codes are occupied is computed by

$$\tilde{p}(j) = \begin{cases} 0 & \text{if } j < 0 \\ 1 & \text{if } j = 0 \\ \sum_{s=1}^S \tilde{p}(j - c_s) a_s \frac{c_s}{j} & \text{if } 1 < j \leq C \end{cases} \quad (1)$$

$$p(j) = \tilde{p}(j) / \sum_{i=0}^C \tilde{p}(i) \quad (2)$$

and the code blocking probability of service s is

$$B(s) = \sum_{j=C-c_s+1}^C p(j). \quad (3)$$

The soft capacity of the UMTS downlink is limited by the multiple access interference and the resulting required sector transmit power, respectively. According to [1], the downlink load is defined as

$$\eta_{DL} = \sum_{k \in \mathcal{M}_z} \left[\nu_k \frac{R_k \varepsilon_k}{W} (\alpha + \bar{f}_{DL}) \right] = \sum_{k \in \mathcal{M}_z} r_k \quad (4)$$

and the pole capacity of a WCDMA sector is reached for $\eta_{DL} = 1$, which means that infinite transmit power is required. Here, the set of mobiles in sector z is \mathcal{M}_z , the activity factor of mobile k is ν_k , and \bar{f}_{DL} is the mean downlink other-cell to own-cell interference ratio which according to [10] is equal to 0.55. Using this definition of soft capacity, the blocking probabilities are also computed by the Kaufman-Roberts recursion. A first comparison of code capacity and soft capacity is given in Fig. 3 that shows the code and soft blocking probabilities for the two services defined in Tab. 2. The common channels occupy 32 SF512 code equivalents which leads to a available code capacity of $C = 480$. The offered load on the x-axis is given in SF512 code equivalents. The code blocking of both services lies between the soft blocking probabilities for $\alpha = 0.0$ and $\alpha = 0.1$. Furthermore, the code blocking increases slower with the offered load than the soft blocking. Thus, we conclude from these first results that code and soft capacity are in balance for users with 100% activity ($\nu = 1$) and orthogonality factors below 0.1. However, we have to consider that, first, the formula for the pole soft capacity in Eqn. (4) is only a worst case approximation assuming that all NodeBs transmit with full

power and, second, that effects like soft handover, sectorization, and softer handover are not included. Therefore, the Monte Carlo simulation technique is used in order to get a better understanding how these effects influence the code and soft capacity.

5 A “semi-analytic” Monte Carlo simulation model

The Monte Carlo simulation generates a series of system snapshots for a UMTS network with given NodeB sites and sectors. A snapshot defines the number and location of the mobiles according to a spatial process, in our case the spatial homogeneous Poisson process. The service and the activity (transmitting or not transmitting) of every mobile are determined and the propagation gains from all sectors to all mobiles are calculated including path gains and lognormal shadowing. When all random influences in a snapshot are determined, the required codes and the required transmit power are computed. If the codes of the P-Sc are not sufficient, the excessive mobiles are allocated to the S-Sc and again, the transmit power is evaluated. The rest of this section describes how to compute the required NodeB transmit powers for a snapshot.

A UMTS network consists of a set \mathcal{B} of NodeBs and the set of sectors at a NodeB x is \mathcal{Z}_x . The P-Sc of sector z is denoted as $c_{z,1}$ and the S-Sc is $c_{z,2}$. The set of all sectors is \mathcal{Z} and the set of all scrambling codes, primary and secondary ones, is \mathcal{C} .

A snapshot consists of a set of mobiles \mathcal{M} . Every mobile k operates with service s_k that is defined by the spreading factor f , bit rate R_s , the E_b/N_0 -target $\hat{\varepsilon}_s$ and the activity factor ν_s . The set of available services is \mathcal{S} . The propagation gain from a sector z to a mobile k that is located in the sector is $d_{z,k} = -128.1 - 37.6 \cdot \log_{10} dist_{z,k} + \theta$, where θ is the lognormal shadowing with 6dB standard deviation. If a mobile is located outside the sector angle no power is received. The relation of transmit power S_z to received power $S_{rec,z,k}$ is in decibels $S_{rec,z,k} = S_z + d_{z,k}$ or in linear scale $\hat{S}_{rec,z,k} = \hat{S}_z \cdot \hat{d}_{z,k}$. Note that we mark linear values by a $\hat{\cdot}$. Additionally, we define that \hat{S}_z is the total transmit power of a sector z , \hat{T}_F is the constant power for common and shared channels, \hat{T}_k is the transmit power for the dedicated channel(s) of mobile k , and \hat{S}_c is the total transmit power for scrambling code c . The set of mobiles that use scrambling code c is \mathcal{M}_c and

$\mathcal{Z}_k = \{z | d_{z,k} \geq \max_x d_{x,k} - RR\}$ is the active set of k with reporting range $RR = 6dB$. \mathcal{C}_k is the set of scrambling codes used for the mobile. The total transmit power of the P-SC and S-Sc are

$$\hat{S}_{c_{z,1}} = \hat{T}_F + \sum_{k \in \mathcal{M}_{c_{z,1}}} \hat{T}_k, \hat{S}_{c_{z,2}} = \sum_{k \in \mathcal{M}_{c_{z,2}}} \hat{T}_k \quad (5)$$

and the total power of the sector is $\hat{S}_z = \hat{S}_{c_{z,1}} + \hat{S}_{c_{z,2}}$. The transmit power for every mobile has to fulfill the E_b/N_0 requirement at the receiver. Assuming perfect power control the following equations define the transmit powers for every mobile k

$$\hat{\epsilon}_k = \frac{W}{R_k} \sum_{c \in \mathcal{C}_k} \frac{\hat{T}_k \cdot \hat{d}_{Z(c),k}}{W \cdot \hat{N}_0 + \hat{I}_{c,k} + \hat{T}_k \cdot \sum_{c' \in \mathcal{C}_k \setminus c} \hat{d}_{Z(c'),k}}. \quad (6)$$

The function $Z(c)$ yields the sector of a scrambling code c . In the denominator of this equation we distinguish the multiple access interference $\hat{I}_{c,k}$ caused by transmissions to other mobiles and the interference caused by other transmissions to mobile k due to soft and softer handover. Note that all sectors in the active set of a mobile transmit with equal power as long as no power drifting due to erroneous power control commands occurs. The interference $I_{c,k}$ from transmissions to other mobiles consists of the interference from other sectors and the interference from the own sector. The interference from the own sector is again distinguished to the interference from the same scrambling code which is reduced by the orthogonality factor α and the interference from the other scrambling code. Accordingly, the interference is

$$\begin{aligned} \hat{I}_{c,k} &= \hat{I}_{c,k}^{(1)} + \hat{I}_{c,k}^{(2)} + \hat{I}_{c,k}^{(3)} + \hat{I}_{c,k}^{(4)} \text{ with} \\ \hat{I}_{c,k}^{(1)} &= \sum_{z \in \mathcal{Z} \setminus \mathcal{Z}_k} \hat{S}_z \cdot \hat{d}_{z,k} \text{ sectors not in active set} \\ \hat{I}_{c,k}^{(2)} &= \sum_{z \in \mathcal{Z}_k \setminus Z(c)} (\hat{S}_z - \hat{T}_k) \cdot \hat{d}_{z,k} \text{ other sectors in active set} \\ \hat{I}_{c,k}^{(3)} &= \alpha \cdot (\hat{T}_c - \hat{S}_k) \cdot \hat{d}_{Z(c),k} \text{ own scrambling code} \\ \hat{I}_{c,k}^{(4)} &= \hat{T}_{\bar{c}} \cdot \hat{d}_{Z(c),k} \text{ other scrambling code (same sector)}. \end{aligned} \quad (7)$$

Now we compute the transmit powers by an iterative process. The first step starts without multiple access interference and computes the required transmit powers of every

single mobile. The transmit powers for every scrambling code and sector are the respective sums of these. In the second step the multiple access interference follows according to Eqn. (7) with the transmit powers from the previous step. The transmit powers for every single mobile follows by solving Eqn. (6) including the new multiple access interference. Then, the transmit powers per sector/scrambling code and the resulting interference are computed again and the process is repeated until the transmit powers converge.

The most complicated part in the iterative process is to compute the transmit power of a mobile according to Eqn. (6), since the equation cannot be solved directly for \hat{T}_k . Instead, the transmit power is the minimum positive root of a polynomial $P(\hat{T}_k)$ that follows by transforming Eqn. (6). For an improved readability we introduce the variables

$$\hat{X}_{c,k} = W \cdot \hat{N}_0 + \hat{I}_{c,k}, Y_{c,k} = \sum_{c' \in \mathcal{C}_k \setminus c} \hat{d}_{Z(c'),k}, \text{ and } \omega_k = \frac{\hat{\epsilon}_k^* R_k}{W}.$$

Using these notations we transform Eqn. (6) to

$$\omega_k = \sum_{c \in \mathcal{C}_k} \frac{\hat{T}_k \cdot \hat{d}_{Z(c),k}}{X_{c,k} + \hat{T}_k \cdot Y_{c,k}}. \quad (8)$$

Then, the minimum positive root of the polynomial

$$P(\hat{T}_k) = \omega_k \prod_{c \in \mathcal{C}_k} (X_{c,k} + \hat{T}_k \cdot Y_{c,k}) - \hat{T}_k \sum_{c \in \mathcal{C}_k} \prod_{c' \in \mathcal{C}_k \setminus c} \hat{d}_{Z(c'),k} (X_{c,k} + \hat{T}_k \cdot Y_{c,k}) \quad (9)$$

is the required transmit powers. The degree of the polynomial corresponds to the size of the active set of the mobile.

6 Numerical Results

In this section we answer two questions: First, is the downlink capacity code or power limited? Second, how much does the S-Sc increase the capacity? Therefore, we consider a hexagonal network with two tiers, i.e. 19 NodeBs. Every NodeB has three sectors and the orientation of the sectors is 0° , 120° , and 240° . We investigate the impact of soft

and softer handover, of the orthogonality factor, of the sector load, of the users' activity, and of the reservation of codes and power for the HSDPA. Therefore, we generate 250 snapshots for every simulated point and evaluate for every snapshot if the primary code tree provides sufficient codes in all sectors and if the required transmit power of every sector stays below the maximum of 10W. The different plots in Fig. 4 contain four curves each that show the probability that sufficient resources are available. The "codes" curve represents the probability that the codes of the P-Sc are sufficient. The "power" curve shows the probability that the power is sufficient in the theoretical case that all mobiles of one sector use the primary scrambling code. The "code and power" curve shows the probability that both the codes and the NodeB power are sufficient when only the P-Sc is used. And finally, the "S-Sc power" curve indicates the probability that the power resources are sufficient if a S-Sc is used. So, the capacity enhancement of the S-Sc is seen when comparing the "codes and power" and the "S-Sc power" curves.

Fig. 4(a) demonstrates the impact of soft and softer handover (reporting range 6dB, 130° sectors) on the downlink capacity. We investigate the scenario with the service mix in Tab. 2 and an offered load of 16 mobiles per sector, an orthogonality factor of 0.2, 100% activity, and 2000mW reserved for common channels. Without soft handover, the codes of one OVSF tree are sufficient with more than 97%. In the few remaining cases using the S-Sc leads to a valid power allocation. This changes if soft and softer handover are considered. Due to the code overhead, the primary code tree is not sufficient with 77% and 63%, respectively, while the power is sufficient with 95% and 75%. Using the S-Sc increases the probability that all mobiles can be served by more than 10%.

In the following we investigate the most realistic softer handover scenario in more detail. First, we vary the orthogonality factor from zero (perfect orthogonality) to 0.4 in Fig. 4(b). Obviously, changing the orthogonality factor has no impact on the available resources from the primary OVSF tree so the probability that there are sufficient codes in the primary code tree alone remains constant. However, a lower orthogonality factor leads to less interference from other users on the same scrambling code and consequently less NodeB power is required. With perfect orthogonality the capacity is clearly code

limited and using a secondary scrambling can compensate for the code leakage with about 95%. For α between 0.2 and 0.3 the downlink capacity switches from code limited to power limited, i.e. the “codes and power” curve gets closer to the “power” curve than to the “codes” curve. The impact of the S-Sc, i.e. the difference between the “S-Sc power” curve and “codes and power” curve diminishes for higher orthogonality factors.

Until now we considered users with 100% activity only. More realistic are users with lower activities. Therefore, we consider the scenario with $\alpha = 0.3$ that is clearly power limited at full activity. Fig. 4(c) shows the impact of lower activities from 50% to 100%. With $\nu = 0.8$, the downlink capacity is already entirely code limited as the “codes” and the “codes and power” curves coincide. With the S-Sc, the probability that there are sufficient resources for all mobiles increases from 63% to 90% for $\nu = 0.8$ and to almost 100% for $\nu = 0.5$.

Fig. 4(d) shows the downlink capacity with and without S-Sc. The orthogonality factor is set to $\alpha = 0.3$ and the activity factor of both services is 75%. The downlink capacity corresponds to the maximum offered load such that the probability of outage is less than p_{out}^* or, the other way round, that with $1 - p_{out}^*$ there are sufficient resources. If we choose p_{out}^* as 5%, the capacity with the P-Sc only is 13 users per sector and the S-Sc increases it to 15 users per sector. For $p_{out}^* = 10\%$, the capacity increases from about 14 users per sector to about 16 users per sector. So at this point we can conclude that the S-Sc increases the capacity, especially for low orthogonality factors and low user activities. If the users have a high activity (>90%) and the orthogonality factor is high (>0.3) using the S-Sc is not beneficial. Note at this point the difference to the results on code blocking in Fig. 3 where code and soft blocking were in balance for an orthogonality factor of 0.1 and the code blocking probabilities were much smaller. The reason for this is first, that now we consider a network and not a single sector, second, that we do not consider the pole capacity with all sectors transmitting at full power but the minimum possible power allocation at all sectors, and, third, the code overhead due to softer handover is included now.

Finally, let us investigate what happens if some SF16 codes and a constant part of

the sector transmit power is reserved for the HSDPA. We consider the scenario with an offered load of 12 users per sector, 75% activity, and an orthogonality factor of 0.3. In Fig. 4(e) the HSDPA occupies 4 SF16 codes such that there are 352 SF512 codes free for dedicated channels on the primary code tree. The power spent for the HSDPA is varied from 500mW to 4000mW. In Fig. 4(f) the power for the HSDPA is fixed at 2000mW and the number of SF16 codes varies from 1 to 8. We can see that the configuration of the HSDPA has great impact of the code and power capacity and also on the capacity enhancement by using the S-Sc. If the HSDPA uses little power for many codes, the capacity is code limited and using the S-Sc is very beneficial. In contrast, if there is much power for few codes, the capacity is already power limited such that the S-Sc cannot be used. We can conclude that when designing the HSDPA, one should consider that the power and the number of codes for the HSDPA should keep the code and power capacity for the dedicated channels in balance.

7 Conclusion

The objective of this paper was to find out in which cases the UMTS downlink capacity is code limited and in which cases the capacity is power limited. Therefore, a semi-analytic Monte Carlo simulation model was developed that is on the one hand detailed enough to cover the effects of sectorization, soft and softer handover on the required channelization codes and transmit power. On the other hand, the simulation is fast enough to compute a number of snapshots that is sufficient for making statistically significant statements.

Our first result is, that the code and power capacity are roughly balanced if the users are always transmitting and if the orthogonality factor is between 0.2 and 0.3. For a higher orthogonality factor, i.e. less orthogonality according to our definition, the capacity becomes power limited and, vice versa, for lower activities or lower orthogonality factors the capacity becomes code limited. In the latter cases installing a secondary scrambling code can lead to a significant increase in capacity. However, a sophisticated admission control mechanism should be applied when using the secondary scrambling code since the increase in interference by an additional user on the secondary scrambling

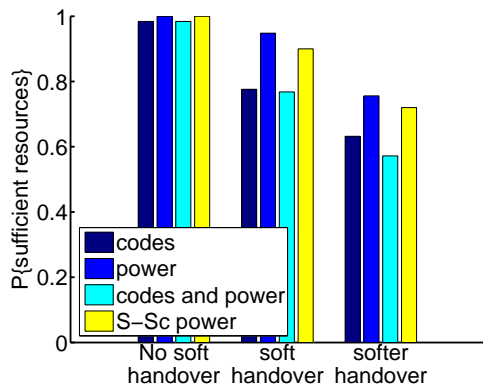

(a) soft/softer handover

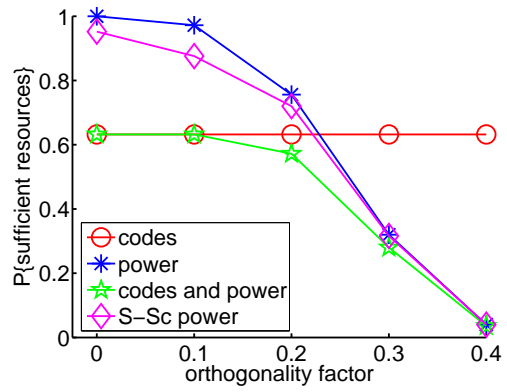

(b) orthogonality factor

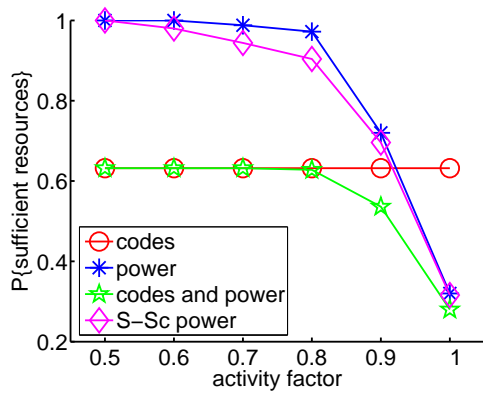

(c) activity factor

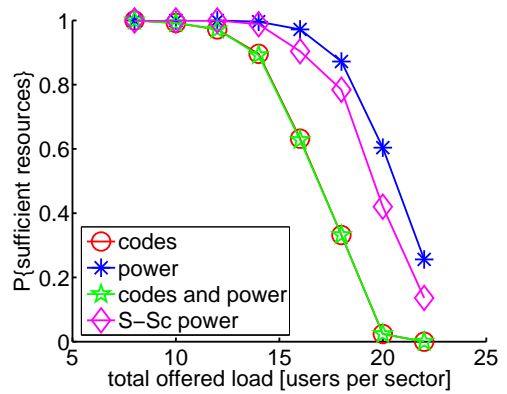

(d) offered sector load

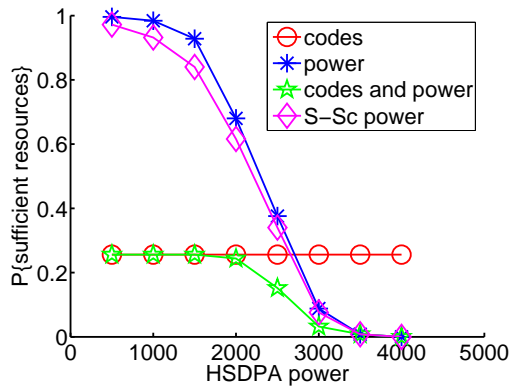

(e) HSDPA power

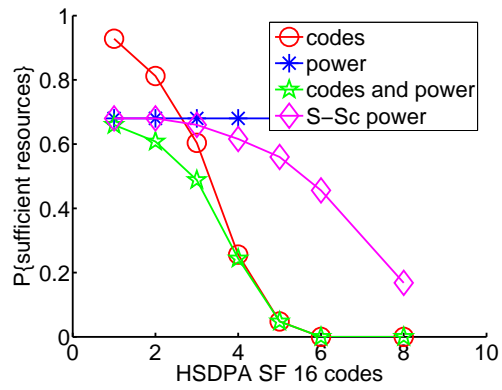

(f) HSDPA codes

Figure 4: Capacity enhancement by using a secondary scrambling code

code is much larger than by an additional user on the primary scrambling code.

Additionally, we found out that reserving codes and power for the future HSDPA can affect the balance between code and soft capacity. Therefore, the resources assigned to the HSDPA should be designed such that no code or power resources for the dedicated channels are wasted by inhibiting the full use of one resource through insufficient capacity of the other resource.

References

- [1] K. Sipilä, Z. Honkasalo, J. Laiho-Steffens, and A. Wacker, "Estimation of capacity and required transmission power of WCDMA downlink based on a downlink pole equation," in *Proc. of IEEE VTC Spring*, (Tokyo, Japan), May 2000.
- [2] D. Staehle and A. Mäder, "An analytic model for deriving the bts transmit power in heterogeneous UMTS networks," in *Proc. of IEEE VTC Spring*, May 2004.
- [3] Y. Yang and T.-S. P. Yum, "Maximally flexible assignment of orthogonal variable spreading factor codes for multirate traffic," *IEEE Trans. on Wireless. Comm.*, vol. 3, pp. 781–792, May 2004.
- [4] A. Rouskas and D. Skoutas, "Ovsf code assignment and reassignment at the forward link of W-CDMA 3G systems," in *Proc. of IEEE PIMRC*, (Lisboa, Portugal), Sept. 2002.
- [5] J. Laiho, A. Wacker, and T. Novosad, *Radio Network Planning and Optimisation for UMTS*. John Wiley & Sons, Ltd., 2002.
- [6] J. Perez-Romero, O. Sallent, and R. Agusti, "Power and code shortage in UTRA-FDD downlink dedicated channels," in *Proc. of IEEE PIMRC*, (Beijing, China), 2003.
- [7] F. Brouwer, "Performance analysis and allocation strategy for the WCDMA second scrambling code," in *IFIP Personal Wireless Communications*, (Delft, The Netherlands), Sept. 2004.

- [8] J. Kaufman, "Blocking in a Shared Resource Environment," *IEEE Trans. on Comm.*, vol. 29, Oct. 1981.
- [9] J. W. Roberts, *Performance of Data Communication Systems and their Applications*. North Holland, 1981.
- [10] H. Holma and A. T. (Eds.), *WCDMA for UMTS*. John Wiley & Sons, Ltd., 3rd ed., Sep. 2004.